

# Multi-Channel Function Generator

MFG-2000 Series

---

## QUICK START GUIDE

GW INSTEK PART NO. 82MF-2K000MB1



ISO-9001 CERTIFIED MANUFACTURER

**GW INSTEK**

This manual contains proprietary information, which is protected by copyright. All rights are reserved. No part of this manual may be photocopied, reproduced or translated to another language without prior written consent of Good Will Corporation.

The information in this manual was correct at the time of printing. However, Good Will continues to improve its products and therefore reserves the right to change the specifications, equipment, and maintenance procedures at any time without notice.

**Good Will Instrument Co., Ltd.**  
**No. 7-1, Jhongsing Rd., Tucheng Dist., New Taipei City 236, Taiwan.**

# Table of Contents

<b>S</b>	<b>SAFETY INSTRUCTIONS.....</b>	<b>4</b>
<b>G</b>	<b>GETTING STARTED .....</b>	<b>9</b>
	Main Features.....	9
	Panel Overview.....	11
	Setting Up the function Generator.....	23
<b>Q</b>	<b>QUICK REFERENCE .....</b>	<b>25</b>
	How to use the Digital Inputs.....	27
	How to use the Help Menu.....	29
	Display area allocation .....	32
	Selecting a Waveform .....	33
	Modulation.....	35
	Sweep.....	44
	Burst .....	46
	ARB .....	48
	Utility Menu .....	53
	Menu Tree .....	54
	Default Settings.....	72
	MFG-2000 Series Specifications .....	74
	EC Declaration of Conformity .....	84
	GLOBL HEADQUARTERS.....	85

# S SAFETY INSTRUCTIONS

This chapter contains important safety instructions that should be followed when operating and storing the function generator. Read the following before any operation to ensure your safety and to keep the function generator in the best condition.

## Safety Symbols

These safety symbols may appear in this manual or on the instrument.

---



Warning: Identifies conditions or practices that could result in injury or loss of life.



Caution: Identifies conditions or practices that could result in damage to the function generator or to other objects or property.



**DANGER** High Voltage



Attention: Refer to the Manual



Protective Conductor Terminal



Earth (Ground) Terminal



**DANGER** Hot Surface



Double Insulated



Do not dispose electronic equipment as unsorted municipal waste. Please use a separate collection facility or contact the supplier from which this instrument was purchased.

## Safety Guidelines

---

### General Guideline





### CAUTION

- Do not place heavy objects on the instrument.
- Do not place flammable objects on the instrument.
- Avoid severe impact or rough handling that may damage the function generator.
- Avoid discharges of static electricity on or near the function generator.
- Use only mating connectors, not bare wires, for the terminals.
- The instrument should only be disassembled by a qualified technician.

(Measurement categories) EN 61010-1:2010 (Third Edition) specifies the measurement categories and their requirements as follows. The MFG-2000 falls under category II.

- Measurement category IV is for measurement performed at the source of a low-voltage installation.
  - Measurement category III is for measurement performed in a building installation.
  - Measurement category II is for measurement performed on circuits directly connected to a low voltage installation.
  - Measurement category I is for measurements performed on circuits not directly connected to Mains.
-

---

Power Supply	<ul style="list-style-type: none"><li>• AC Input voltage: 100 ~ 240V AC, 50 ~ 60Hz. Or 100 ~ 120V AC, 220 ~ 240V AC, 50 ~ 60Hz (With power amplifier)</li><li>• Connect the protective grounding conductor of the AC power cord to an earth ground to prevent electric shock.</li></ul>
 WARNING	
Fuse	Fuse type: T0.5A/250V. T1A/250V(With power amplifier).
 WARNING	<ul style="list-style-type: none"><li>• Only qualified technicians should replace the fuse.</li><li>• To ensure fire protection, replace the fuse only with the specified type and rating.</li><li>• Disconnect the power cord and all test leads before replacing the fuse.</li><li>• Make sure the cause of fuse blowout is fixed before replacing the fuse.</li></ul>
Cleaning the function generator	<ul style="list-style-type: none"><li>• Disconnect the power cord before cleaning the function generator.</li><li>• Use a soft cloth dampened in a solution of mild detergent and water. Do not spray any liquid into the function generator.</li><li>• Do not use chemicals containing harsh products such as benzene, toluene, xylene, and acetone.</li></ul>
Operation Environment	<ul style="list-style-type: none"><li>• Location: Indoor, no direct sunlight, dust free, almost non-conductive pollution (Note below) and avoid strong magnetic fields.</li><li>• Relative Humidity: &lt; 80%</li><li>• Altitude: &lt; 2000m</li><li>• Temperature: 0°C to 40°C</li></ul>

---

(Pollution Degree) EN 61010-1:2010(Third Edition) specifies pollution degrees and their requirements as follows. The function generator falls under degree 2.

Pollution refers to “addition of foreign matter, solid, liquid, or gaseous (ionized gases), that may produce a reduction of dielectric strength or surface resistivity”.

- Pollution degree 1: No pollution or only dry, non-conductive pollution occurs. The pollution has no influence.
- Pollution degree 2: Normally only non-conductive pollution occurs. Occasionally, however, a temporary conductivity caused by condensation must be expected.
- Pollution degree 3: Conductive pollution occurs, or dry, non-conductive pollution occurs which becomes conductive due to condensation which is expected. In such conditions, equipment is normally protected against exposure to direct sunlight, precipitation, and full wind pressure, but neither temperature nor humidity is controlled.

---

#### Storage environment

- Location: Indoor
- Relative Humidity: < 70%
- Temperature: -10°C to 70°C

---

#### Disposal



Do not dispose this instrument as unsorted municipal waste. Please use a separate collection facility or contact the supplier from which this instrument was purchased. Please make sure discarded electrical waste is properly recycled to reduce environmental impact.

## Power cord for the United Kingdom

When using the function generator in the United Kingdom, make sure the power cord meets the following safety instructions.

NOTE: This lead/appliance must only be wired by competent persons

 **WARNING: THIS APPLIANCE MUST BE EARTHED**

IMPORTANT: The wires in this lead are coloured in accordance with the following code:

Green/ Yellow:	Earth
Blue:	Neutral
Brown:	Live (Phase)



As the colours of the wires in main leads may not correspond with the coloured marking identified in your plug/appliance, proceed as follows:

The wire which is coloured Green & Yellow must be connected to the Earth terminal marked with either the letter E, the earth symbol  or coloured Green/Green & Yellow.

The wire which is coloured Blue must be connected to the terminal which is marked with the letter N or coloured Blue or Black.

The wire which is coloured Brown must be connected to the terminal marked with the letter L or P or coloured Brown or Red.

If in doubt, consult the instructions provided with the equipment or contact the supplier.

This cable/appliance should be protected by a suitably rated and approved HBC mains fuse: refer to the rating information on the equipment and/or user instructions for details. As a guide, a cable of 0.75mm<sup>2</sup> should be protected by a 3A or 5A fuse. Larger conductors would normally require 13A types, depending on the connection method used.

Any exposed wiring from a cable, plug or connection that is engaged in a live socket is extremely hazardous. If a cable or plug is deemed hazardous, turn off the mains power and remove the cable, any fuses and fuse assemblies. All hazardous wiring must be immediately destroyed and replaced in accordance to the above standard.



# GETTING STARTED

The Getting started chapter introduces the function generator’s main features, appearance, set up procedure and power-up.

## Main Features

MFG-2000 series specific functions						
Model	CH1	CH2	25MHz Pulse Generator	RF Generator (function with ARB)	Power Amplifier	Modulation /Sweep/Burst/ Frequency Counter
	Function With 200MSa/sARB	Function With 200MSa/sARB				
MFG-2110	●10MHZ		●			
MFG-2120	●20MHZ		●			
MFG-2120MA	●20MHZ		●		●	●
MFG-2130M	●30MHZ		●			●
MFG-2160MF	●60MHZ		●	●160MHZ		●
MFG-2160MR	●60MHZ		●	●320MHZ		●
MFG-2230M	●30MHZ	●30MHZ	●			●
MFG-2260M	●60MHZ	●60MHZ	●			●
MFG-2260MFA	●60MHZ	●60MHZ	●	●160MHZ	●	●
MFG-2260MRA	●60MHZ	●60MHZ	●	●320MHZ	●	●

- Performance
- DDS Function Generator series
  - 1μHz high frequency resolution maintained at full range
  - 20ppm frequency stability
  - Arbitrary Waveform Capability
  - 200 MSa/s sample rate
  - 100 MSa/s repetition rate
  - 16k-point waveform length
  - 10 groups of 16k waveform memories
  - True waveform output to display

- User-defined output section
  - User-defined marker output section
  - DWR (Direct Waveform Reconstruction) capability
  - Ability to edit waveforms without a PC
  - -60dBc low distortion sine wave
- 

**Features**

- Sine, Square, Ramp, Pulse, Noise waveforms
  - Internal and external LIN/LOG sweep with marker output
  - Int/Ext AM, FM, PM, FSK, SUM, PWM modulation
  - Burst function with internal and external triggers
  - 42Vpk signal ground chassis isolation
  - Pulse waveform with configurable rise times & fall times
  - Store/recall 10 groups of setting memories
  - Output overload protection
- 

**Interface**

- USB interface as standard, LAN interface(MFG-22XX only)
- 4 inch Color TFT LCD (480 X 272) graphical user interface
- AWES (Arbitrary Waveform Editing Software) PC software

# Panel Overview

## MFG-2260MRA/2260MFA Front Panel

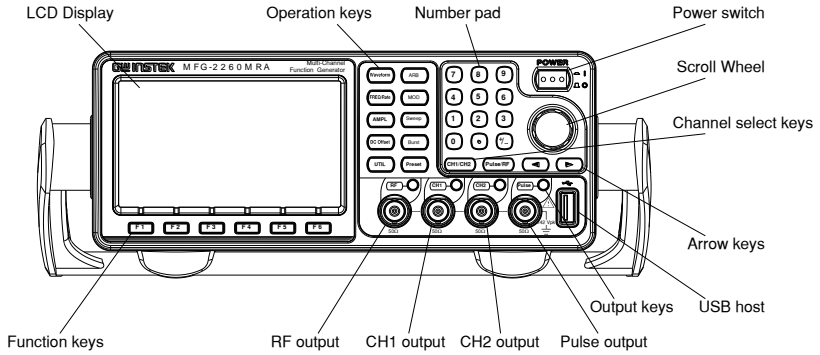

## MFG-2160MR/2160MF Front Panel

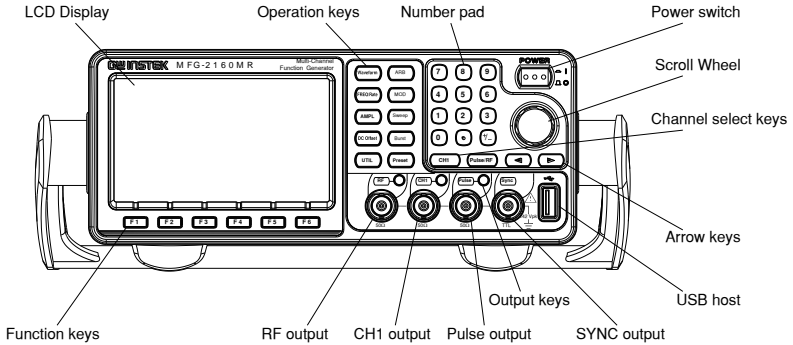

### MFG- 2120MA/2130M Front Panel

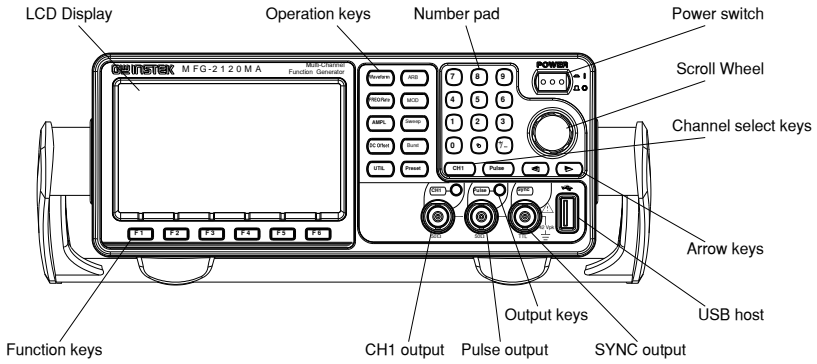

### MFG- 2110/2120 Front Panel

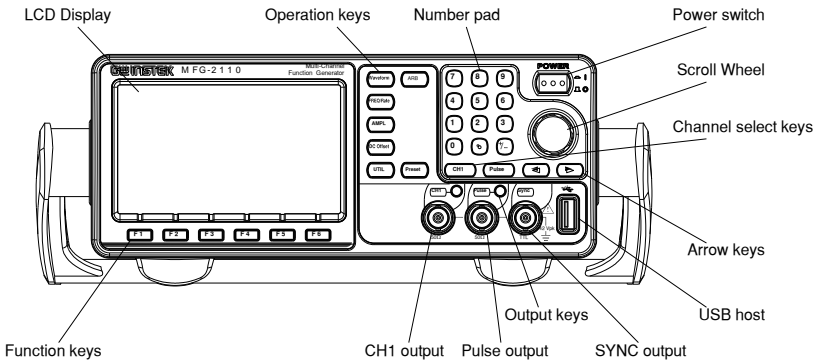

## MFG- 2260M/2230M Front Panel

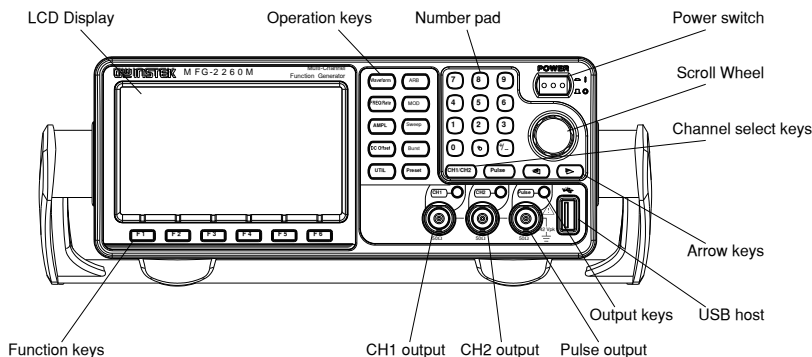

LCD Display TFT color display, 480 x 272 resolution.

Function  
Keys  
F1~F6

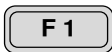

Activates functions that appear on the bottom of the LCD screen.

Operation  
Keys



The waveform key is used to select a type of waveform.



The FREQ/Rate key is used to set the frequency or sample rate.



AMPL sets the waveform amplitude.



Sets the DC offset.



The UTIL key is used to access the save and recall options, update and view the firmware version, access the calibration options, system setting, Dual channel functions and frequency meter.



ARB is used to set the arbitrary waveform parameters.

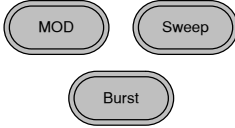

The MOD, Sweep and Burst keys are used to set the modulation, sweep and burst settings and parameters.

Preset Key



The preset key is used to recall a preset state.

Output Key



The Output key is used to turn on or off the waveform output.

Channel Select Keys



The channel select key is used to switch between the four output channels.

Output ports

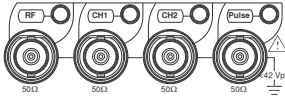

CH1: Channel 1 output port  
 CH2: Channel 2 output port  
 Pulse: Pulse output port  
 RF: RF output port

Power Button



Turns the power on or off.

USB Host



USB type-A host port.

Arrow Keys



Used to select digits when editing parameters.

Scroll Wheel

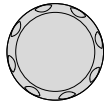

The scroll wheel is used to edit values and parameters.

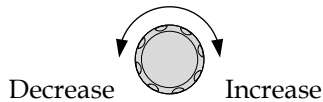

Keypad

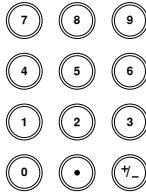

The digital keypad is used to enter values and parameters. The keypad is often used in conjunction with the arrow keys and variable knob.

---

### MFG-2260MRA/2260MFA Rear Panel

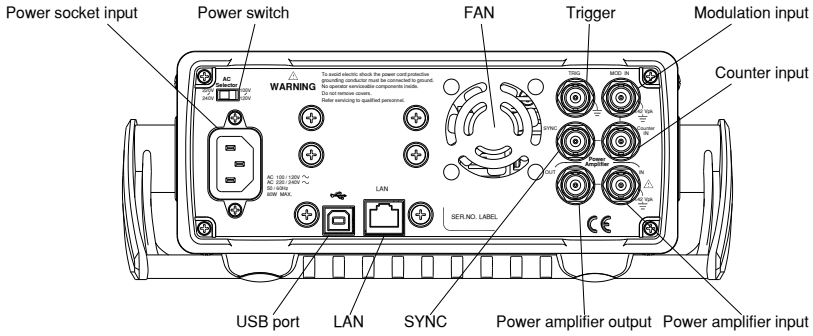

### MFG-2120MA Rear Panel

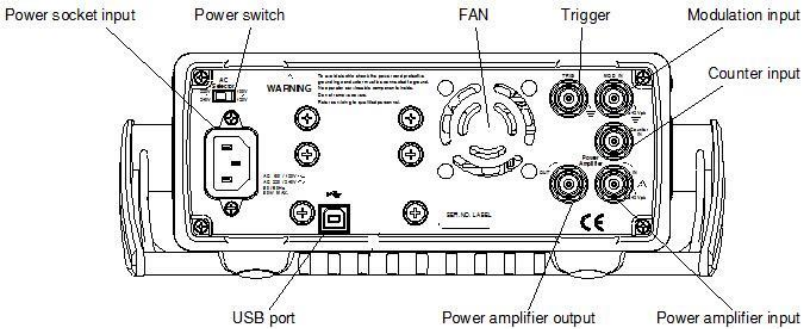



### MFG-2160MR/2160MF/2130M Rear Panel

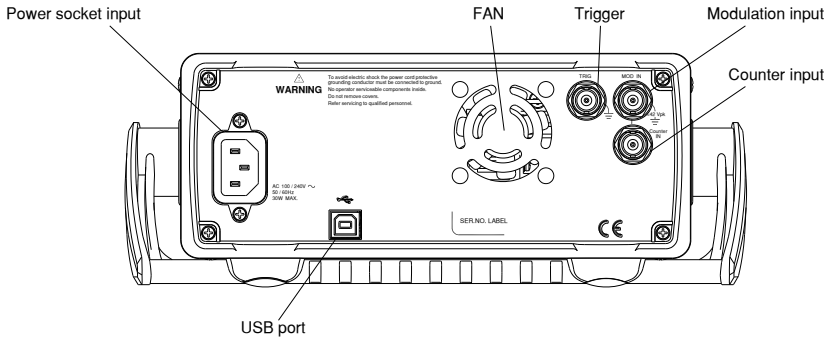

### MFG-2260M/2230M Rear Panel

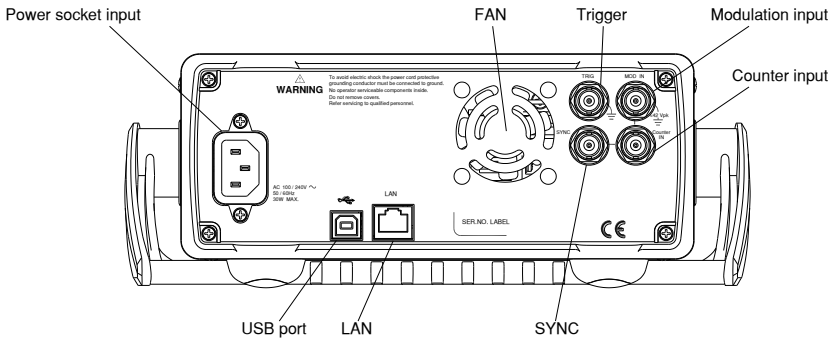

## MFG-2110/2120 Rear Panel

Power socket input

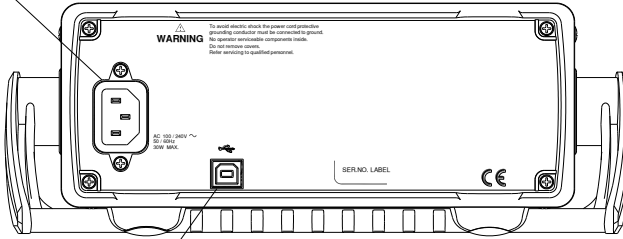

USB port

Trigger

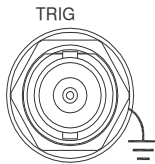

TRIG

Please refer to the tables on Page 21.

Sync

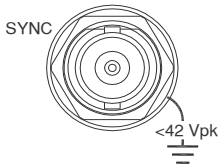

SYNC

Please refer to the tables on Page 21.

Fan

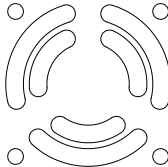

Fan.

Power Input  
Socket

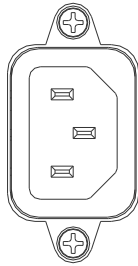

AC 100 / 120V ~  
AC 220 / 240V ~  
50 / 60Hz  
80W MAX.

Power input:  
100~240V AC  
50~60Hz. Or  
100~120V AC  
220~240V AC  
50~60Hz.

Power Switch

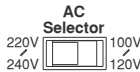

Selects AC voltage: 100V~120V  
Or 220V~240V.  
This function can only be used  
in the models with power  
amplifier machines such as  
MFG-2120MA, MFG-  
2260MFA, MFG-2260MRA.

LAN Port

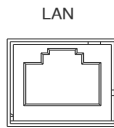

The LAN port is used for  
remote control over a network  
(MFG-22XX only)

USB Device  
Port



USB type-B device port is used  
to connect the function  
generator to a PC for remote  
control.

Counter Input

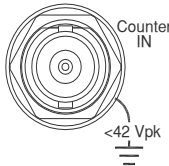

Frequency counter input.

MOD Input

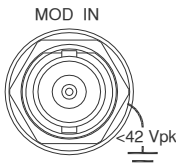

Please refer to the tables on  
Page 21.

Power  
Amplifier in

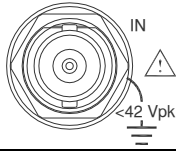

Power Amplifier input port

---

Power  
Amplifier out

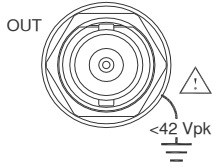

Power Amplifier output port

---

**21XX:**

Terminal	Function	Mode
Trigger	Trigger in(EXT)	CH1:FSK,SWEEP,BURST RF:ASK,FSK,PSK,BURST
	Trigger out	CH1:BURST
	Marker	CH1:SWEEP,ARB
MOD IN	EXT	CH1:AM,FM,PM,SUM,PWM
SYNC	Sync signal output	CH1

**22XX:**

Terminal	Function	Mode
Trigger		CH1/CH2:FSK,SWEEP,BURST RF:ASK,FSK,PSK,SWEEP,BURST
MOD IN	EXT	CH1/CH2:AM,FM,PM,SUM,BURST
SYNC	Trigger out	CH1/CH2:SWEEP.BURST
	Marker	CH1/CH2:SWEEP.ARB
	Sync signal output	CH1,CH2

## Display

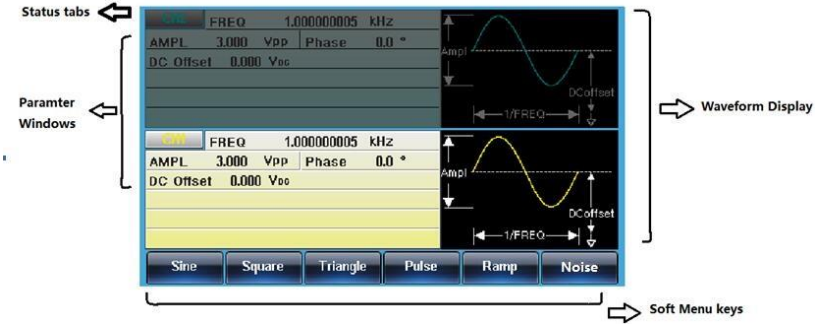

Parameter Windows	The Parameter display and edit window.
Status Tabs	Displays the current channel and setting status.
Waveform Display	Used to display the waveform
Soft Menu Keys	The function keys (F1~F6) under the LCD display correspond directly to the soft menu keys.

## Setting Up the function Generator

---

**Background** This section describes how to adjust the handle and power up the function generator.

---

### Adjusting the Handle

Pull out the handle sideways and rotate it.

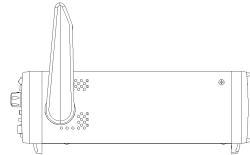

Place the MFG-2000 horizontally,

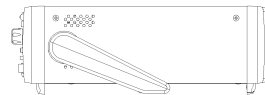

Or tilt the stand.

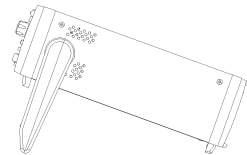

Place the handle vertically to hand carry.

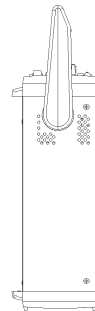

### Power Up

1. Connect the power cord to the socket on the rear panel.

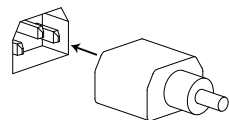

2. Turn on the power switch on the front panel.

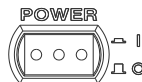

3. When the power switch is turned on the screen displays the loading screen.



The function generator is now ready to be used.



# QUICK REFERENCE

This chapter describes the operation shortcuts, built-in help and factory default settings. This chapter is to be used as a quick reference, for detailed explanations on parameters, settings and limitations, please see the operation chapters.

How to use the Digital Inputs .....	27
How to use the Help Menu .....	29
Display area allocation .....	32
Selecting a Waveform .....	33
Square Wave.....	33
Ramp Wave .....	33
Sine Wave.....	34
Modulation .....	35
AM .....	35
ASK .....	36
FM .....	37
FSK .....	38
PM .....	39
PSK .....	40
PWM.....	41
SUM.....	42
Sweep .....	44
Burst.....	46
ARB .....	48
ARB—Add Built-In Waveform.....	48
ARB—Add Point.....	48
ARB—Add Line .....	50
ARB—Output Section.....	50
ARB—Output N Cycle.....	51
ARB—Output Infinite Cycles .....	52
ARB—Output Marker .....	52

Utility Menu .....	53
Save .....	53
Recall .....	53
Menu Tree .....	54
Waveform .....	55
ARB_Display .....	56
ARB_Edit .....	57
ARB_Built In .....	58
ARB_Save .....	59
ARB_Load .....	60
ARB_Output .....	60
MOD_(CH1/CH2) .....	61
MOD_(Sine-DDS) .....	62
MOD_(Sine-ARB) .....	63
SWEEP .....	64
Burst_N Cycle .....	65
Burst_Gate .....	66
UTIL_(22XX) .....	67
UTIL_(21XX) .....	70
CH1/CH2 .....	71
Pulse/RF .....	71
Default Settings .....	72
MFG-2000 Series Specifications .....	74
EC Declaration of Conformity .....	84
GLOBAL HEADQUARTERS .....	85

## How to use the Digital Inputs

### Background

The MFG-2000 has three main types of digital inputs: the number pad, arrow keys and scroll wheel. The following instructions will show you how to use the digital inputs to edit parameters.

1. To select a menu item, press the corresponding function keys below (F1~F6). For example the function key F1 corresponds to the Soft key "Sine".



2. To edit a digital value, use the arrow keys to move the cursor to the digit that needs to be edited.

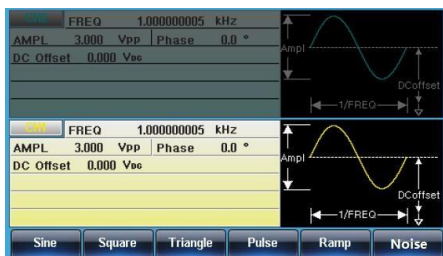

3. Use the scroll wheel to edit the parameter. Clockwise increases the value, counter clockwise decreases the value.

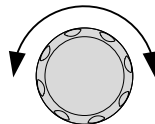

4. Alternatively, the number pad can be used to set the value of a highlighted parameter.

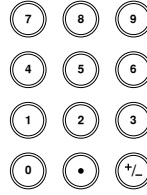

## How to use the Help Menu

**Background** Every key and function has a detailed description in the help menu.

1. Press UTIL



2. Press System (F4)



3. Press Help (F3)



4. Use the scroll wheel to navigate to a help item. Press Select to choose the item.

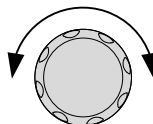

Keypad	Provides help on any front panel key that is pressed.
Create Arbitrary Waveform	Provides help on creating arbitrary waveforms.
Modulation Function	Explains how to create Modulated waveforms.

- Sweep Function Provides help on the Sweep function.
- Burst Function Provides help on the Burst function.
- DSO Link Provides help on DSO link.
- Hardcopy Explains how to use the Hardcopy function.

5. For example, select item 4 to see help on the sweep functions.

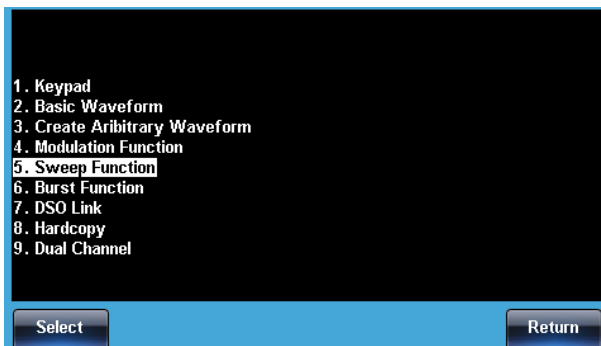

6. Use the scroll wheel to navigate the help information.

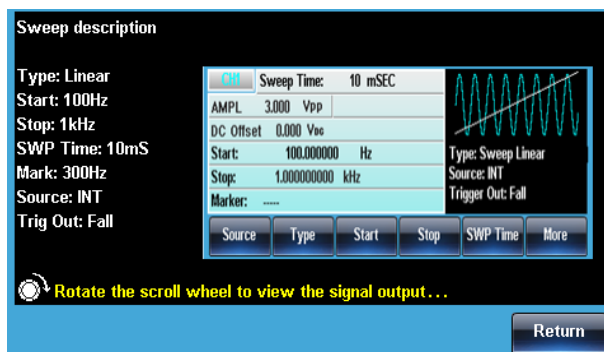

7. Press Return to return to the previous menu.

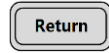

## Display area allocation

Output channel MFG is divided into 21XX and 22XX two series of 10 models. It has mainly 4 different output channels CH1/ CH2/ Pulse/ RF to collocate with, CH1/ Pulse is standard configuration and CH2/ RF is optional. The display position for CH1 is fixed and the display position for Pulse changes depending on if the the CH2 available.

In order to effectively distinguish various channels, we assign different color to each channel respectively.

CH1 Yellow

CH2 Blue

Pulse Pink

RF Orange

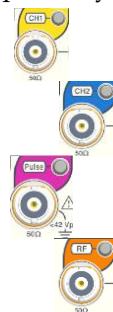

DSO Link This function is only for the 22XX series models. The procedure for switching channel is list below:

21XX

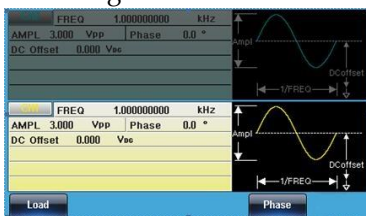

22XX

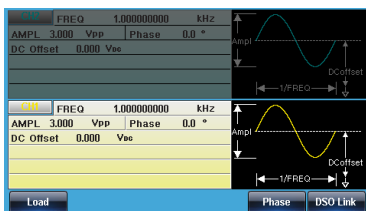



## Selecting a Waveform

### Square Wave

Example: Square wave, 3Vpp, 75% duty cycle, 1kHz.

Output:

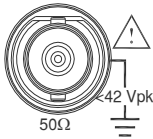

1. Press Waveform and select Square (F2).



2. Press Duty (F1), 7 + 5 + % (F5).



Input: N/A

3. Press Freq/Rate, 1 + kHz (F5).



4. Press AMPL followed by, 3 + VPP (F6).



5. Press the Output key.



### Ramp Wave

Example: Ramp Wave, 5Vpp, 10kHz, 50% Symmetry.

Output:

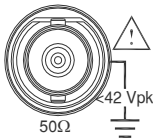

1. Press the Waveform key, and select Ramp (F5).



2. Press SYM(F1), 5 + 0 + % (F5).



Input: N/A

3. Press the Freq/Rate key then 1 + 0 + kHz (F5).



4. Press the AMPL key then 5 +VPP (F6).



5. Press the Output key.



## Sine Wave

Example: Sine Wave, 10Vpp,100kHz

Output:

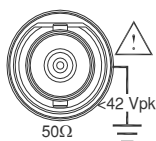

Input: N/A

1. Press the Waveform key and select Sine (F1).



2. Press the Freq/Rate key, followed by 1 + 0 +0 + kHz (F5).

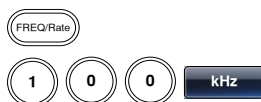

3. Press the AMPL key, followed by 1 + 0 +VPP (F6).



4. Press the output key.



# Modulation

## AM

Example: AM modulation. 100Hz modulating square wave. 1kHz Sine wave carrier. 80% modulation depth.

Output:

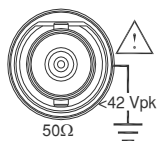

1. Press the MOD key and select AM (F1).



2. Press Waveform and select Sine (F1).



Input: N/A

3. Press the Freq/Rate key, followed by 1 + kHz (F5).



4. Press the MOD key, select AM (F1), Shape (F4), Square (F2).



5. Press the MOD key, select AM (F1), AM Freq (F3).



6. Press 1 + 0 + 0 + Hz (F2).





7. Press the MOD key, select AM (F1), Depth (F2).



8. Press 8 + 0 + % (F1).



9. Press MOD, AM (F1), Source (F1), INT (F1).
- 

10. Press the Output key.
- 

## ASK

Example: ASK modulation. 50% duty cycle. 1kHz sine carrier wave. 10Hz rate . Internal source.

Output:

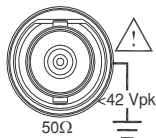



1. Press MOD and then select ASK(F2).
- 

2. Press Waveform and select Sine(F1).
- 

Input: N/A



3. Press the Freq/Rate key, followed by 1 + kHz (F5).
- 

4. Press the MOD key, select ASK(F2), ASK Rate (F3).
- 

5. Press 1+ 0 + Hz (F2)
- 

6. Press the MOD key, select ASK(F5), ASK Ampl(F2).
- 

7. Press 5+0+0+mVpp(F5).
- 



8. Press MOD, ASK(F5), Source (F1), INT (F1).
 
9. Press the Output key.
 

## FM



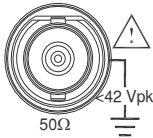

Example: FM modulation. 100Hz modulating square wave. 1kHz Sine wave carrier. 100 Hz frequency deviation. Internal Source.



Output:

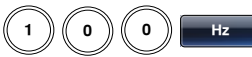

1. Press the MOD key and select FM (F2).
 
2. Press Waveform and select Sine (F1).
 

Input: N/A

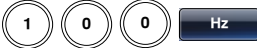
3. Press the Freq/Rate key, followed by 1 + kHz (F5).
 
4. Press the MOD key, select FM (F2), Shape (F4), Square (F2).
 
5. Press the MOD key, select FM (F2), FM Freq (F3).
 
6. Press 1 + 0 + 0 + Hz (F2).
 
7. Press the MOD key, select FM (F2), Freq Dev (F2).
 



8. Press 1 + 0 + 0 + Hz (F3).
 
9. Press MOD, FM (F2), Source (F1), INT (F1).
 
10. Press the Output key.
 

## FSK



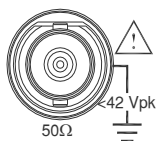

Example: FSK modulation. 100Hz Hop frequency. 1kHz Carrier wave. Sine wave. 10 Hz Rate. Internal Source.



Output:



1. Press the MOD key and select FSK (F3).
 
2. Press Waveform and select Sine (F1).
 

Input: N/A

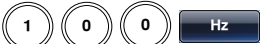
3. Press the Freq/Rate key, followed by 1 + kHz (F5).
 
4. Press the MOD key, select FSK (F3), FSK Rate (F5).
 
5. Press 1 + 0 + Hz (F5).
 
6. Press the MOD key, select FSK (F3), Hop Freq (F5).
 



7. Press 1 + 0 + 0 + Hz (F3). 
8. Press MOD, FSK (F3), Source (F1), INT (F1). 
9. Press the output key. 

## PM



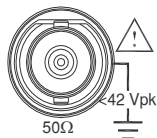

Example: PM modulation. 800Hz sinusoidal carrier wave. 15 kHz modulating sine wave. 180° phase deviation. Internal Source.



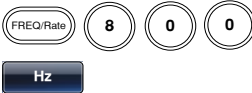

Output:



1. Press Waveform and select Sine (F1). 
2. Press the MOD key and select PM (F4). 

Input: N/A

3. Press the Freq/Rate key, followed by 8 + 0 + 0 + Hz (F4). 
4. Press the MOD key, select PM (F4), Shape (F4), Sine (F1). 
5. Press MOD, then PM (F4), PM Freq (F3). 
6. Press 1 + 5 + kHz (F3). 



7. Press MOD, PM (F4), PM Dev (F5). 
8. Press 5 + 0 + Degree (F1). 
9. Press MOD, PM (F4), Source (F1), INT (F1). 
10. Press the Output key. 

## PSK



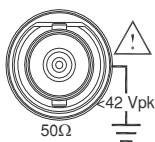

Example: PSK modulation. 50% phase deviation. 1kHz sine carrier wave. 10Hz PSK rate. Internal source.

### Output



1. Press MOD and select PSK (F6). 
2. Press Waveform and select Sine(F1). 

### Input: N/A

3. Press the Freq/Rate key, followed by 1 + kHz (F5). 
4. Press the MOD key, select PSK (F6), PSK Rate (F3). 
5. Press 1 + 0 + Hz (F2). 
6. Press the MOD key, select PSK (F6), PSK Phase (F2). 



7. Press 5+ 0 + % (F3)
8. Press MOD, PSK (F6), Source (F1), INT (F1)
9. Press the Output key

## PWM



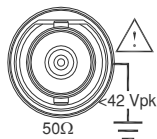

Example: PWM modulation. 800Hz carrier, 15kHz modulated sine wave. 50% duty cycle. Internal source.

Output:



1. Press Waveform and select Square (F2)
2. Press MOD and select PWM (F6)
3. Press the Freq/Rate key, followed by 8+0+0 Hz (F4).
4. Press the MOD key, select PWM (F6), Shape (F4), Sine (F1).
5. Press MOD, select PWM (F6), PWM Freq (F3)
6. Press 1 + 5+ kHz (F3).

Input: N/A

7. Press MOD, select PWM(F6),Duty(F2)
 
8. Press 5 + 0 + % (F1)
 
9. Press MOD, PWM(F6), Source(F1),INT(F1)
 
10. Press the Output key.
 

## SUM

Example: SUM modulation. 100Hz modulating square wave, 1kHz sinusoidal carrier wave, 50% SUM amplitude, internal source.

Output:

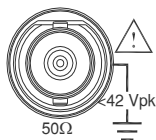



1. Press the MOD key, then SUM (F5).
 





2. Press Waveform, and select Sine (F1).
 

Input: N/A

3. Press Freq/Rate followed by 1 + kHz (F5).
 

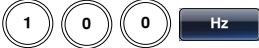
4. Press the MOD key, SUM (F5), Shape (F4), Square (F2).
 

5. Press the MOD key and select SUM (F5), SUM Freq (F3).
 

6. Press 1 + 0 + 0 + Hz (F2). 
7. Press the MOD key and select SUM (F5), SUM Ampl (F2). 
8. Press 5 + 0 + % (F1). 
9. Press MOD, SUM (F5), Source (F1), INT (F1). 
10. Press the Output key. 

# Sweep

Example: Frequency Sweep. Start Frequency 10mHz, Stop frequency 1MHz. Log sweep, 1 second sweep, Marker Frequency 550 Hz, Manual Trigger.

Output:

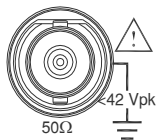

1. Press Sweep, Start (F3).



2. Press 1 + 0 + mHz (F2).



3. Press Sweep, Stop (F4).



Input: N/A

4. Press 1 + MHz (F5).



5. Press Sweep, Type (F2), Log (F2).



6. Press Sweep, SWP Time (F5).



7. Press 1 + SEC (F2).



8. Press Sweep, More (F6), Marker (F3), ON/OFF (F2), Freq (F1).



9. Press 5 + 5 + 0 + Hz (F3).



10. Press the Output key.



11. Press Sweep, Source (F1), Manual (F3), Trigger (F1).



# Burst

Example: Burst Mode, N-Cycle (Internally triggered), 1kHz burst frequency, Burst count = 5, 10 ms Burst period, 0° burst phase, Internal trigger, 10 us delay, rising edge trigger out

Output:

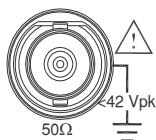

1. Press **FREQ/Rate** 1 kHz (F5).



2. Press **Burst, N Cycle** (F1), **Cycles** (F1).



Input: N/A

3. Press **5 + Cyc** (F5).



4. Press **Burst, N Cycle** (F1), **Period** (F4).



5. Press **1 + 0 + msec** (F2).



6. Press **Burst, N Cycle** (F1), **Phase** (F3).



7. Press **0 + Degree** (F5).



8. Press **Burst, N Cycle** (F1), **TRIG** set (F5), **INT** (F1).



9. Press **Burst, N Cycle** (F1), **TRIG** set (F5), **Delay** (F4).



10. Press **1 + 0 + uSEC** (F2).



11. Press Burst, N Cycle (F1), TRIG setup (F5), TRIG out (F5), ON/OFF (F3), Rise (F1).



12. Press the Output key.



# ARB

## ARB–Add Built-In Waveform

Example: ARB Mode, Exponential Rise. Start 0, Length 100, Scale 327.

Output:

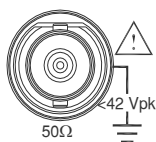

1. Press ARB, Built in (F3), Wave (F4), Math(F2), use the scroll wheel to select Exporise and then press Select(F5).



2. Press Start (F1), 0 + Enter (F2), Return.

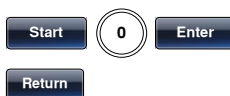

3. Press Length (F2), 100, Enter (F2), Return.



4. Press Scale (F3), 327, Enter (F2), Return, Done (F5).



## ARB–Add Point

Example: ARB Mode, Add point, Address 40, data 300.

Output:

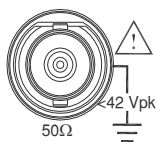

1. Press ARB, Edit (F2), Point (F1), Address (F1).



2. Press 4 + 0 + Enter (F5), Return.





3. Press Data (F2),  
3+0+0, Enter (F5).

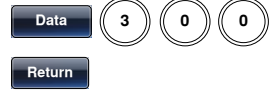

## ARB–Add Line

Example: ARB Mode, Add line, Address:Data (10:30, 50:100)

Output:

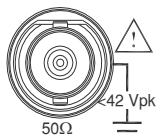

1. Press ARB, Edit (F2), Line (F2), Start ADD (F1).



2. Press 1 + 0 + Enter (F5), Return.



3. Press Start Data (F2), 3 + 0, Enter (F5), Return.



4. Press Stop ADD (F3), 5 + 0, Enter (F5), Return.



5. Press Stop Data (F4), 1 + 0 + 0, Enter (F5), Return, Done (F5).



## ARB–Output Section

Example: ARB Mode, Output ARB Waveform, Start 0, Length 1000.

Output:

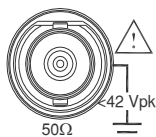

1. Press ARB, Output (F6).



2. Press Start (F1), 0 + Enter (F5), Return.



- Press Length (F2), 1 + 0 + 0, Enter (F5), Return.
 





## ARB–Output N Cycle

---

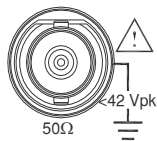
Example: ARB Mode, Output N Cycle, Start 0, Length 1000, N Cycle 10.

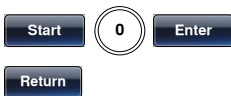
Output:



- Press ARB, Output(F6).
 
- Press Start(F1), 0+Enter (F5), Return(F6).
 
- Press Length(F5), 1+0+0, Enter(F5), Return(F6).
 
- Press N Cycle (F4).
 
- Press Cycle(F1), 1+0.
 
- Press Trigger(F5) to trigger the output once.
 

## ARB–Output Infinite Cycles

Example: ARB Mode, output N cycle, start 0, length 1000, cycles infinite.

Output:

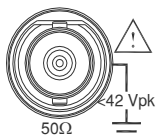

1. Press ARB, Output(F6).



2. Press Start (F1), 0 + Enter (F5), Return(F6).



3. Press Length (F2), 1+0+0+0, Enter (F5), Return (F6).



4. Press Infinite(F5), Return(F6).



## ARB–Output Marker

Example: ARB mode, output marker, Start 30, Length.

Output:

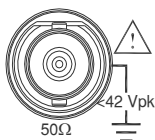

1. Press ARB, Output (F6), Marker (F3).



2. Press Start (F1), 3+0, Enter (F5), Return.



3. Press Length (F2), 8 + 0, Enter (F5), Return.





## Utility Menu

### Save

---



Example: Save to Memory file #5.

1. Press UTIL, Memory (F1), Store (F1).  

2. Choose a setting using the scroll wheel and press Done (F5).  

### Recall

---

Example: Recall Memory file #5.

1. Press UTIL, Memory (F1), Recall (F2).  

2. Choose a setting using the scroll wheel and press Done (F5).  

## Menu Tree

**Conventions** Use the menu trees as a handy reference for the function generator functions and properties. The MFG-2000 menu system is arranged in a hierarchical tree. Each hierarchical level can be navigated with the operation or soft menu keys. Pressing the Return key will return you to the previous menu level.

For example: To set the interface to USB;

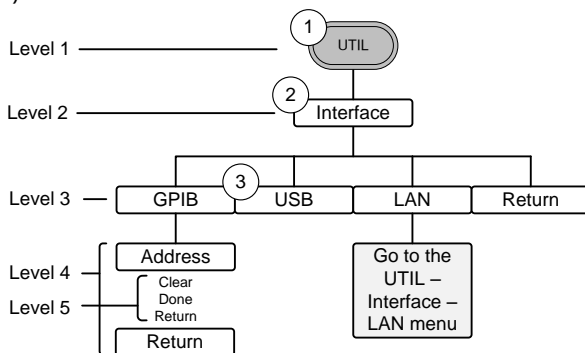
- (1) Press the UTIL key.
- (2) The Interface soft-key.
- (3) USB.



Waveform

---

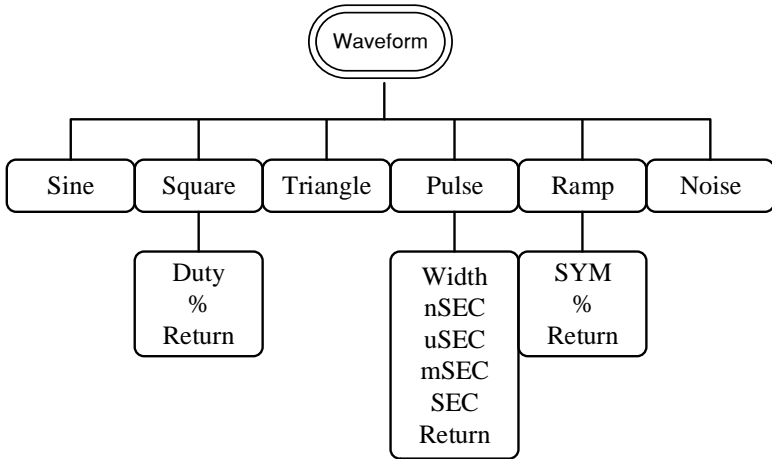

## ARB\_Display

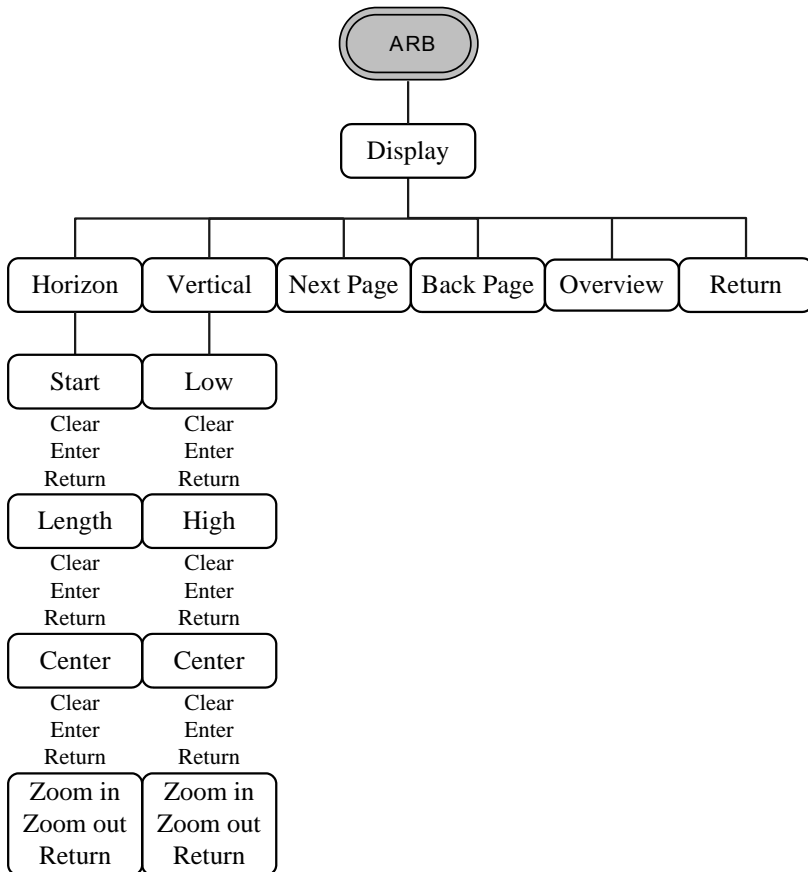



ARB\_Edit

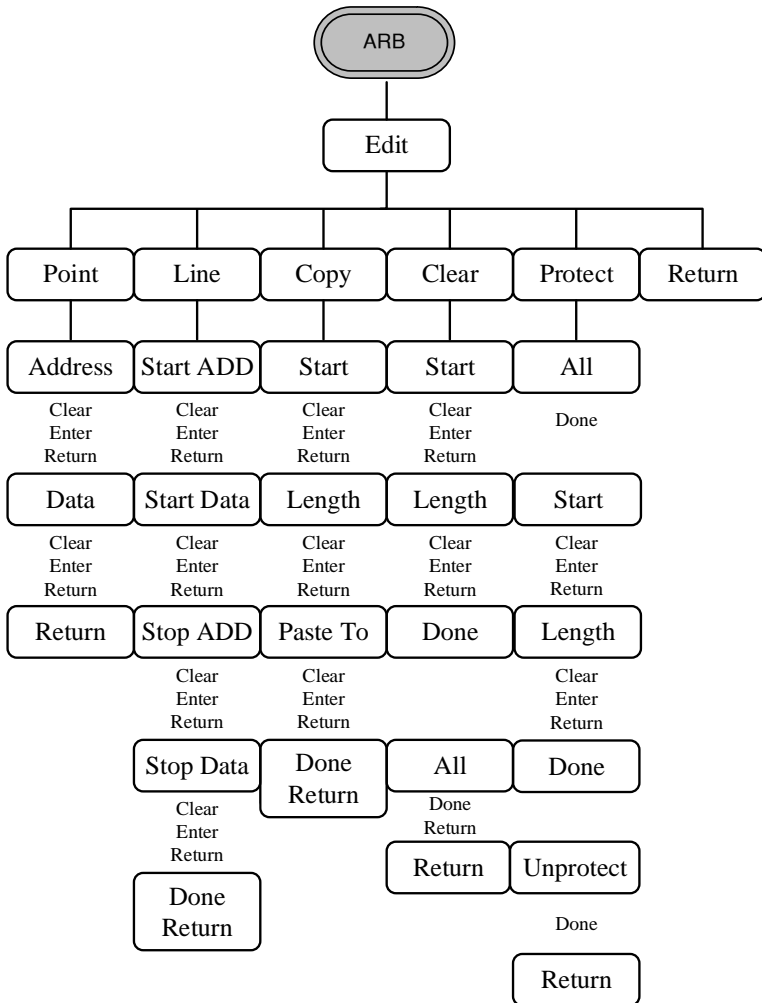

ARB\_Built In

---

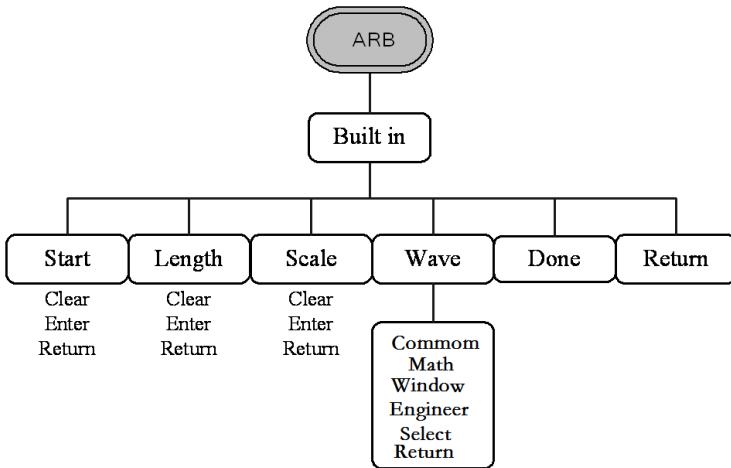

ARB\_Save

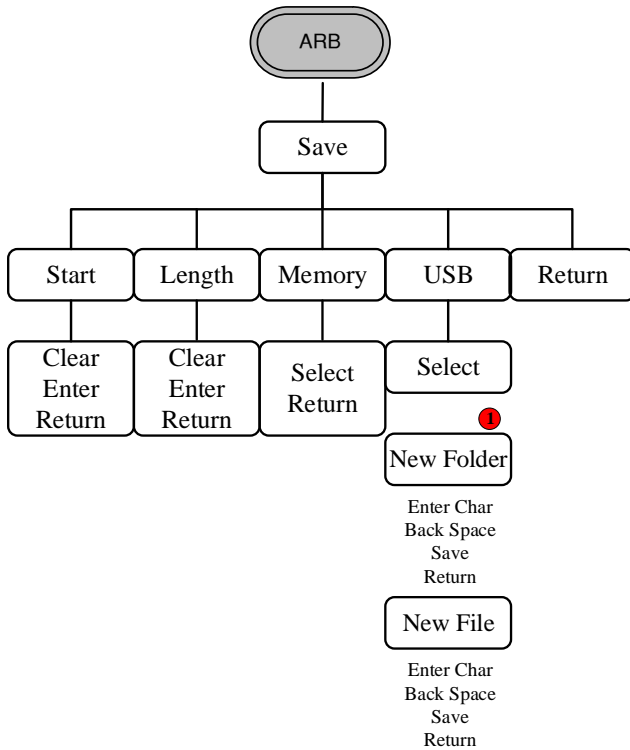

Note

The part “new folder” listed below ❶ is only available in the MFG-22XX series.

### ARB\_Load

---

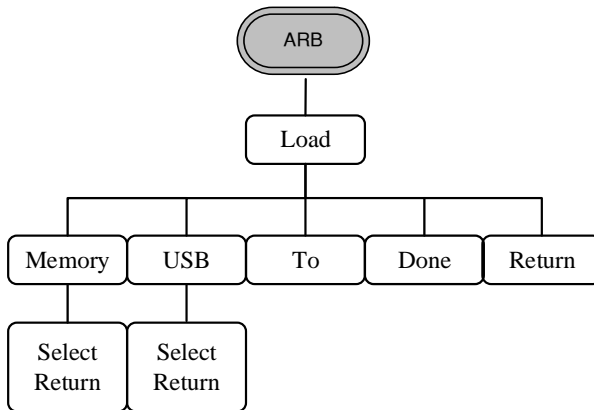

### ARB\_Output

---

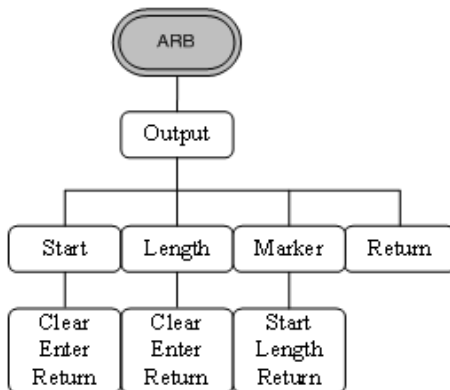

MOD\_(CH1/CH2)

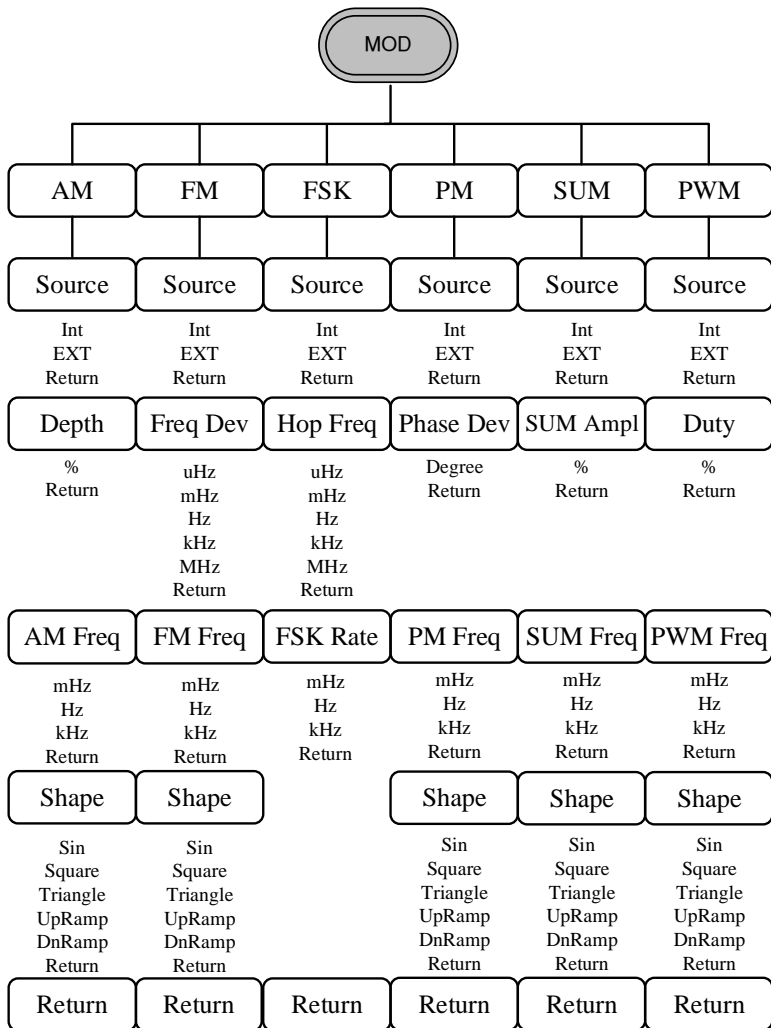

## MOD\_(Sine-DDS)

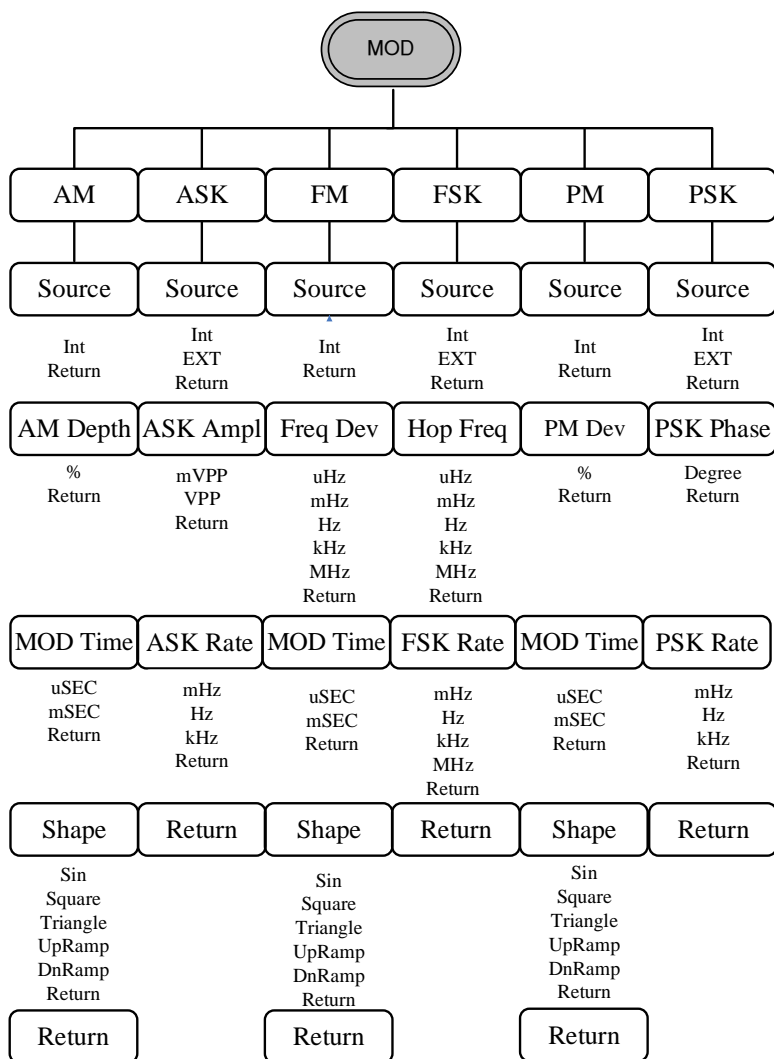

This function is for selecting the modulation function of Sine-DDS under RF waveforms.

MOD\_(Sine-ARB)

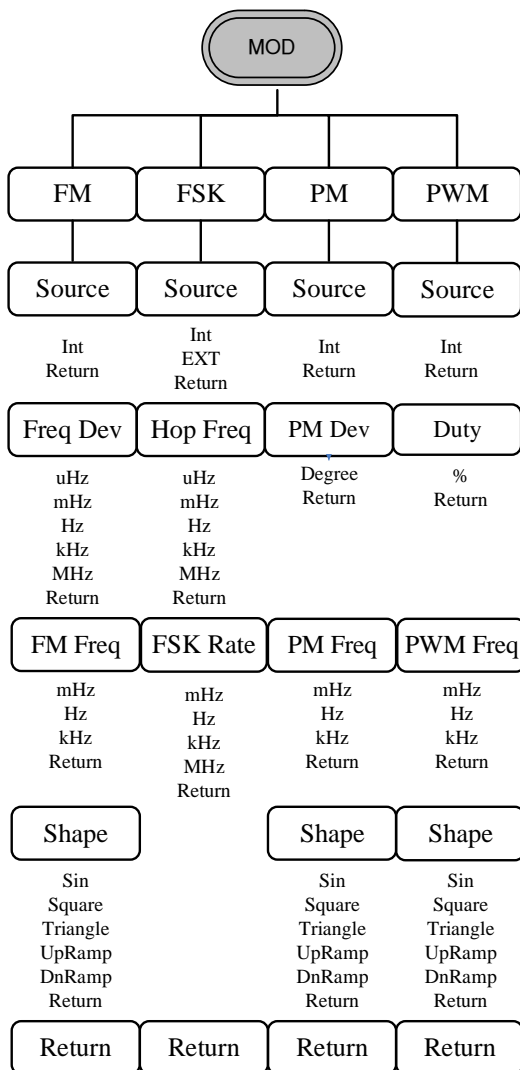

Note

This function is for selecting the modulation function of Sine-ARB under RF waveforms.

**SWEEP**

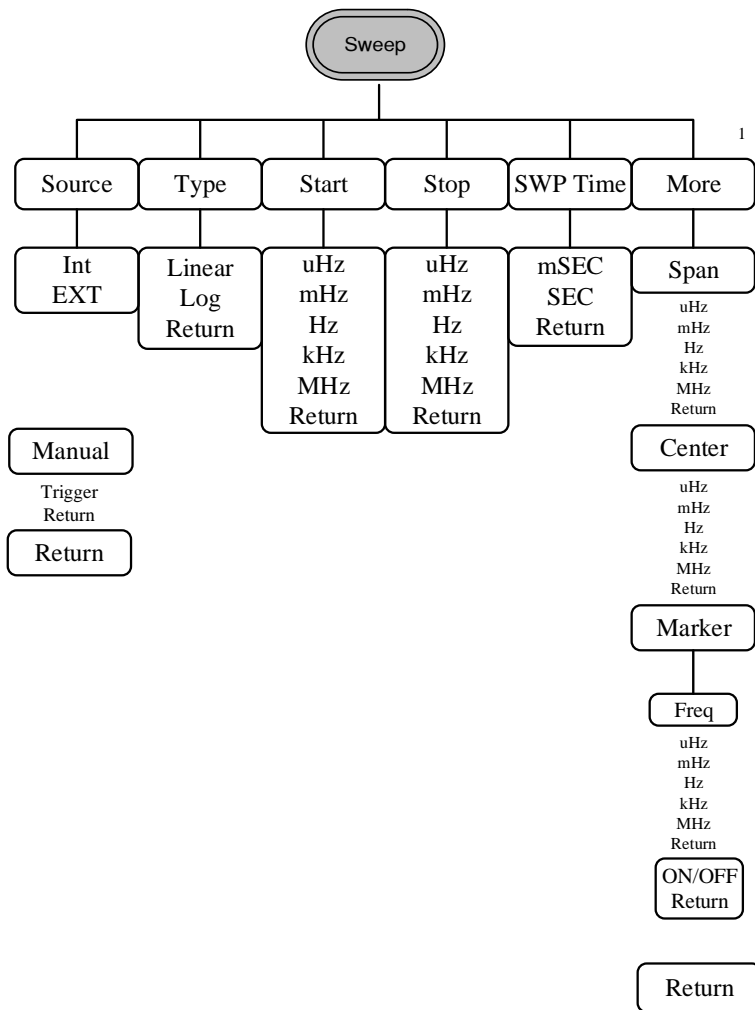



## Burst\_N Cycle

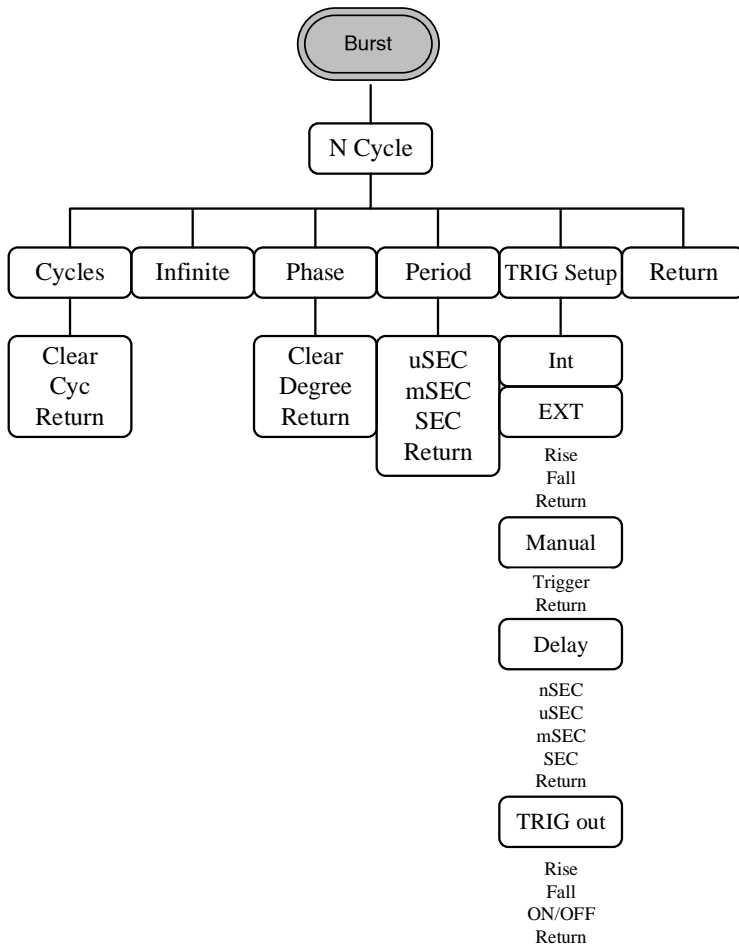

## Burst\_Gate

---

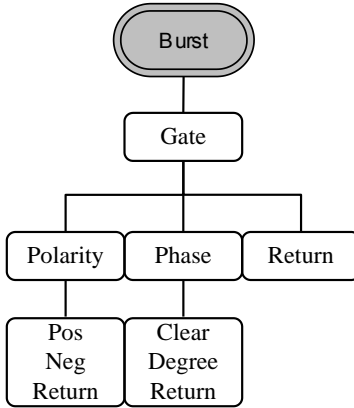

UTIL\_(22XX)

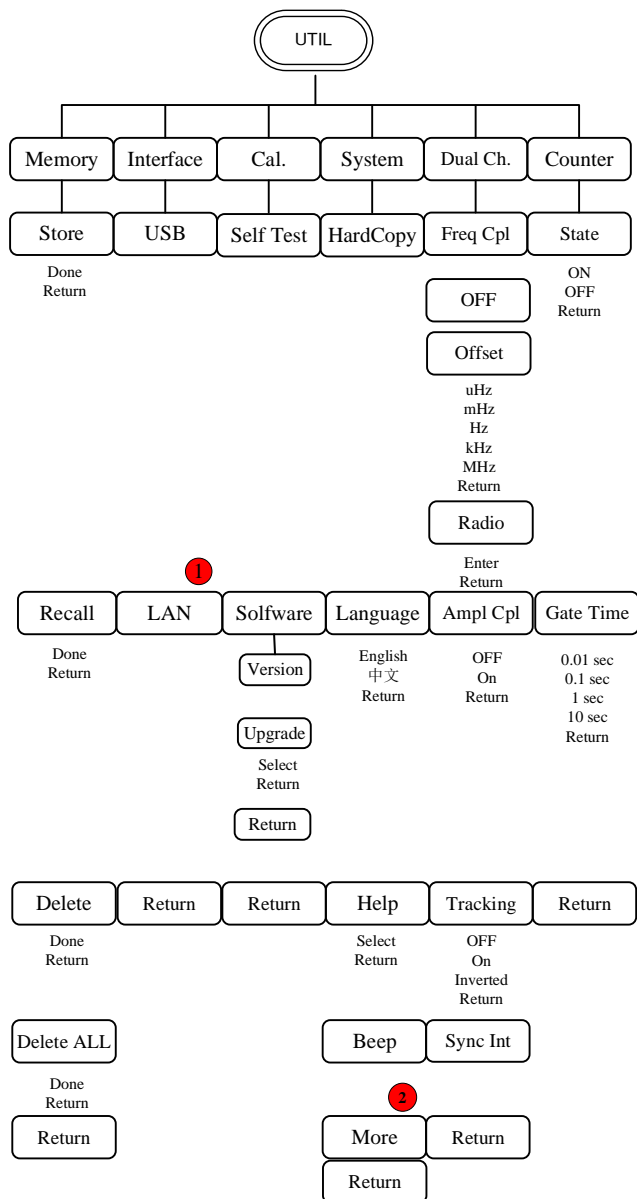

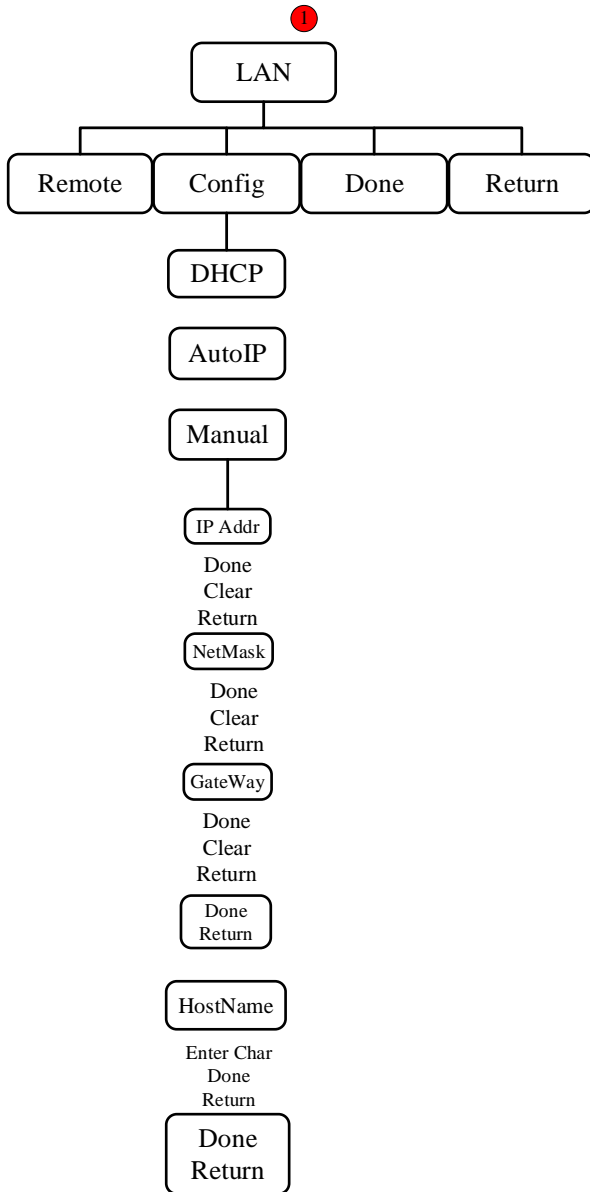

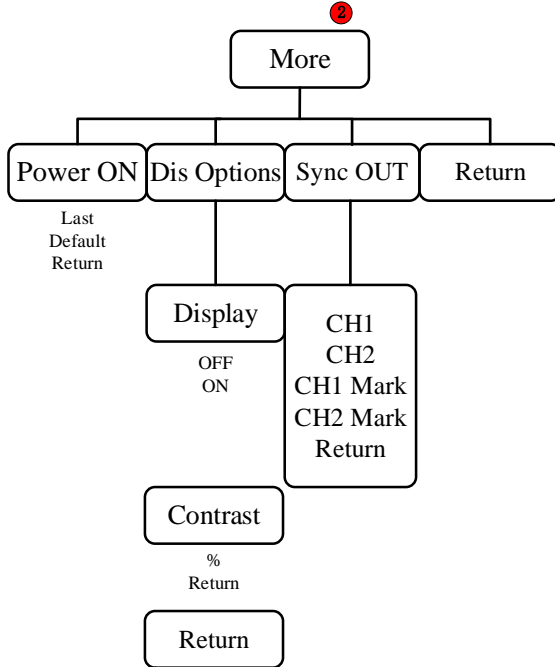

UTIL\_(21XX)

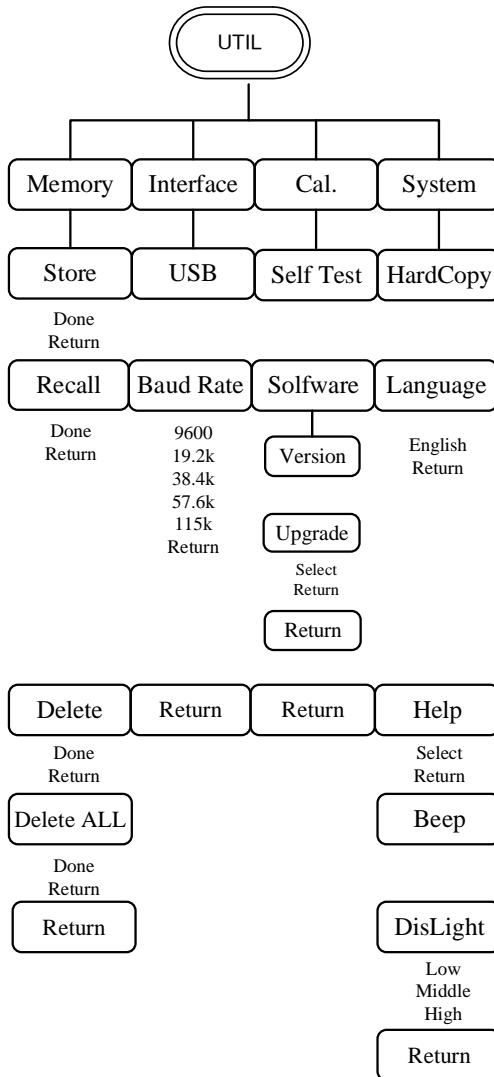

## CH1/CH2

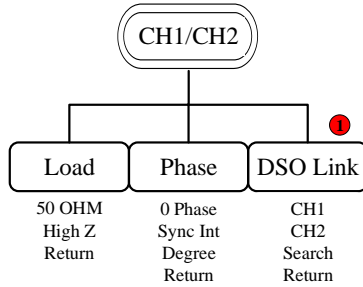

Note

The part “DSO Link” listed below <sup>1</sup> is only available in the MFG-22XX series.

## Pulse/RF

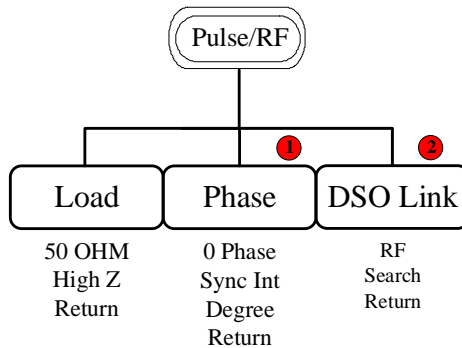

Note

<sup>1</sup> means that phase function is not available on RF channel and <sup>2</sup> means DSO-link function is not available on Pulse channel. DSO-link is only available on the RF channel of MFG-2200X series.

## Default Settings

The Preset key is used to restore the default panel settings.



Output Settings	Function	Sine Wave
	Frequency	1kHz
	Amplitude	3.000 Vpp
	Offset	0.00V dc
	Output units	Vpp
	Output terminal	50Ω
<b>Modulation</b>		
(AM/ASK/FM/FSK/PM/PSK/SUM)	Carrier wave	1kHz sine wave
	Modulation wave	100Hz sine wave
	AM depth	100%
	ASK amplitude	500mVpp
	ASK frequency	10Hz
	FM deviation	100Hz
	FSK hop frequency	100Hz
	FSK frequency	10Hz
	PM phase deviation	180°
	PSK phase	180°
	PSK frequency	10Hz
	SUM amplitude	50%
	Modem status	Off
<b>PWM Modulation</b>		
	Carrier wave	1kHz Square wave
	Modulation wave	20kHz sine wave



	PWM duty cycle	50%
	Modem status	Off
Sweep	Start/Stop frequency	100Hz/1kHz
	Sweep time	1ms
	Sweep type	Linear
	Sweep status	Off
Burst	Burst frequency	1kHz
	Ncycle	1
	Burst period	10ms
	Burst starting phase	0°
	Burst status	Off
System Settings	Power off signal	On
	Display mode	On
	Error queue	Cleared
	Memory settings	No change
	Output	Off
Trigger	Trigger source	Internal (immediate)
Calibration	Calibration Menu	Restricted

# MFG-2000 Series Specifications

The specifications apply when the function generator is powered on for at least 30 minutes under +18°C~+28°C.

MFG-2000 series specific functions						
	CH1	CH2	25MHz Pulse Generator	RF Generator (function with ARB)	Power Amplifier	Modulation /Sweep/Burst/Frequency Counter
	Function With 200MSa/sARB	Function With 200MSa/sARB				
MFG-2110	●10MHZ		●			
MFG-2120	●20MHZ		●			
MFG-2120MA	●20MHZ		●		●	●
MFG-2130M	●30MHZ		●			●
MFG-2160MF	●60MHZ		●	●160MHZ		●
MFG-2160MR	●60MHZ		●	●320MHZ		●
MFG-2230M	●30MHZ	●30MHZ	●			●
MFG-2260M	●60MHZ	●60MHZ	●			●
MFG-2260MFA	●60MHZ	●60MHZ	●	●160MHZ	●	●
MFG-2260MRA	●60MHZ	●60MHZ	●	●320MHZ	●	●

## CH1/ CH2

<b>Waveforms</b>	Standard	Sine, Square, Ramp, Pulse, Noise
<b>Arbitrary Functions</b>	ARB function	Built-in
	Sample Rate	200 MSa/s
	Repetition Rate	100MHz
	Waveform Length	16k points
	Amplitude Resolution	14 bits
	Non-Volatile Memory	10sets 16k points(1)
	User-defined output section	From point 2~16384 (optional)
	User-defined output marker section	From point 2 ~ 16384(optional)
	Output mode	1~1000000 cycles or infinite mode
	Built-in Arbitrary	Absatan, Abssine, Abssinehalf, Amp alt, Attalt, Diric.even, Diric.odd, Gauss puls, Havercosine, Haversin, N_puls e, Negramp, Rectpuls, Roundhalf, Swtoot, Sinetra, Sinever, Stair_down, Stair_ud, Stair_up, Stepresp, Traperia, Tripuls, Airy, Bessel, Beta, Gamma, Legendre, Neemann, Arccos, Arccot, Arcsec, Arcsin, Arcsinh, Arctan, Arctanh, Cosh, Cot, Csc, Dlorentz, ex

pofall,exporise,gauss,ln,lorentz,Se  
c,Sech,Sinc,Sinh,Sqrt,Tan,Tanh,Xs  
quare,Barthannwin,Bartlett,Blackm  
an,Bohmanwin,Chebyshev,Flatttop  
win,Hamming,Hann,Hanning,Kais  
er,Triang,Tukeywin

<b>Frequency Characteristics</b>	Range	Sine	60MHz(max)	
		Square	25MHz(max)	
		Triangle, Ramp	1MHz	
	Resolution		1μHz	
	Accuracy Stability		±20 ppm	
	Aging		±1 ppm, per 1 year	
	Tolerance		≤1μHz	
	<b>Output Characteristics(2)</b>	Amplitude Range	1mVpp to 10 Vpp (into 50Ω) 2mVpp to 20 Vpp (open-circuit)	
Accuracy		±2% of setting ±1 mVpp (at 1 kHz/into 50Ω without DC offset)		
Resolution		0.1mV or 4 digits		
Flatness		± 1% (0.1dB) ≤ 1MHz ± 3% (0.3dB) ≤ 50 MHz ± 16% (1.5dB) ≤ 60MHz (sinewave relative to 1 kHz/into 50Ω)		
Units		Vpp, Vrms, dBm		
<b>Offset</b>		Range	±5 Vpk ac +dc (into 50Ω) ±10Vpk ac +dc (Open circuit)	
		Accuracy	±(1% of setting + 5mV+ 0.5% of amplitude)	
<b>Waveform Output</b>	Impedance	50Ω typical (fixed) >10MΩ (output disabled)		
	Protection	Short-circuit protected Overload relay automatically disables main output		
	Ground Isolation	42Vpk max		
	<b>Sync Output</b>	Range	TTL-compatible into>1kΩ	

	Impedance	50Ω standard
<b>Sine wave Characteristics(3)</b>	Ground Isolation	42Vpk max
	Harmonic distortion	-60 dBc <200kHz, Ampl>0.1 Vpp -55 dBc 200kHz~1 MHz, Ampl>0.1 Vpp -45 dBc 1MHz~10 MHz, Ampl >0.1Vpp -35 dBc 10MHz~30 MHz, Ampl >0.1Vpp -27 dBc 30MHz~60MHz, Ampl >0.1Vpp
	Total harmonic distortion	< 0.1% (Ampl>1Vpp) DC~100 kHz
<b>Square wave Characteristics</b>	Rise/Fall Time	<15ns
	Overshoot	<5%
	Asymmetry	1% of period +5 ns
	Variable duty Cycle	0.01% to 99.99%(limited by the current frequency setting)
	Jitter	20ppm+500ps(4)
	<b>Ramp Characteristics</b>	Linearity
Variable Symmetry		0% to 100%
<b>Pulse Characteristics</b>	Frequency	1uHz~25MHz
	Pulse Width	≧20nS(limited by the current frequency setting)
	Variable duty Cycle	0.01%~99.99%(limited by the current frequency setting)
	Overshoot	<5%
	Jitter	20ppm+500ps(4)
	<b>Pulse Generator</b>	Amplitude

Offset	±1 Vpk ac +dc (into 50Ω) ±2Vpk ac +dc (Open circuit)
Frequency	1μHz~25MHz
Pulse Width	20nS~999.7ks (limited by the current frequency setting)
Variable duty Cycle	0.1%~99.9% (limited by the current frequency setting)
Leading and Trailing Edge Time(5)	10nS~20S (1ns resolution) (limited by the current frequency and pulse width settings)
Overshoot	<5%
Jitter	100ppm+500ps (4)

**RF Generator**

**Arbitrary Functions**

ARB function	Built-in
Sample Rate	200 MSa/s
Repetition Rate	100MHz
Waveform Length	16k points
Amplitude Resolution	8 bits
User-defined output section	From point 2~16384 (optional)
Jitter	20ppm+5ns

**Frequency Characteristics**

Range	Sine	1μHz~160MHz (MFG-2XXXMF) 1μHz~320MHz (MFG-2XXXMR)
	Square	25MHz(max)
	Triangle, Ramp	1MHz
Resolutio	1μHz	
Accuracy Stability	±20 ppm	
Aging	±1 ppm, per 1 year	
Tolerance	≤1μHz	

**Output Characteristics(2)**

Amplitude(into 50Ω)	1mVpp to 2 Vpp (MFG-2XXXMF) 1mVpp to 1 Vpp (MFG-2XXXMR)
---------------------	--

	Accuracy	±2% of setting ±1 mVpp (at 1 kHz/into 50Ω without DC offset)
	Resolution	0.1mV or 4 digits
	Flatness	± 1% (0.1dB) ≤1MHz ± 3% (0.3dB) ≤50 MHz ± 10% (0.9dB) ≤160MHz ± 35% (3.5dB) ≤320MHz (sinewave relative to 1 kHz/into 50Ω)
<b>Offset</b>		±1 Vpk ac +dc (into 50Ω) ±2Vpk ac +dc (Open circuit)
<b>Waveform Output</b>	Impedance	50Ω typical (fixed) >10MΩ (output disabled)
<b>Sine wave Characteristics(3)</b>		
	Harmonic	-60 dBc <200kHz
	Distortion(sine, 1vpp, 50Ω )	-55 dBc 200kHz~1 MHz -45 dBc 1MHz~10 MHz -30 dBc 10MHz~320MHz
	Total harmonic distortion	< 0.1% (Ampl>1Vpp) DC~100 kHz
<b>Square wave Characteristics</b>		
	Rise/Fall Time	<15ns
	Overshoot	<5%
	Asymmetry	1% of period +5 ns
	Variable duty Cycle	0.01% to 99.99%(limited by the current frequency setting)
	Jitter	20ppm+500ps(4)
<b>Ramp Characteristics</b>		
	Linearity	< 0.1% of peak output
	Variable Symmetry	0% to 100%
<b>Modulation/ Sweep</b>		
	Modulation Type	AM,ASK,FM,FSK,PM,PSK,PWM (The detail same as CH1 modulation specification)
	Sweep type	Frequency
	Source	INT/EXT (INT only for

AM,FM,PM, PWM)

<b>PSK</b>	Carrier Waveforms	Sine, Square, Triangle, Ramp,Pulse
	Modulating Waveforms	50% duty cycle square
	Internal Frequency	2mHz to 1 MHz
	Phase Range	0° ~360.0°
	Source	Internal / External
<b>ASK</b>	Carrier Waveforms	Sine, Square, Triangle, Ramp,Pulse
	Modulating Waveforms	50% duty cycle square
	Internal Frequency	2mHz to 1 MHz
	Amplitude Range	0%~100.0%
	Source	Internal / External

**Power Amplifier**

Input Impedance	10KΩ
Input voltage	1.25Vpmax
Working Mode	Constant Voltage
Gain	20dB
Output Power (RL=8Ω)	20W(Square)
Output Voltage	12.5Vpmax
Output Current	1.6Amax
Rise/Fall Time	<2.5uS
FullPower Bandwidth	5Hz-100KHz
Overshoot	5%
Total harmonic distortion	< 0.1% (Ampl>1Vpp) 20Hz~20 kHz
Ground Isolation	42Vpk max

**Advanced Functions**

**AM Modulation**

Carrier Waveforms	Sine, Square, Triangle, Ramp, Pulse,Arb
Modulating Waveforms	Sine, Square, Triangle,Uramp, Dnramp
Modulating Frequency	2mHz to 20kHz (Int)DC to 20kHz (Ext)
Depth	0% to 120.0%

	Source	Internal / External
<b>FM Modulation</b>	Carrier Waveforms	Sine, Square, Triangle, Ramp
	Modulating Waveforms	Sine, Square, Triangle, Up ramp, Dn ramp
	Modulating Frequency	2mHz to 20kHz (Int) DC to 20kHz (Ext)
	Peak Deviation	DC to max frequency
	Source	Internal / External
<b>PM Modulation</b>	Carrier Waveforms	Sine, Square, Triangle, Ramp
	Modulating Waveforms	Sine, Square, Triangle, Up ramp, Dn ramp
	Modulation Frequency	2mHz to 20kHz (Int) DC to 20kHz (Ext)
	Phase deviation	0° ~360.0°
	Source	Internal / External
<b>SUM Modulation</b>	Carrier Waveforms	Sine, Square, Triangle, Ramp
	Modulating Waveforms	Sine, Square, Triangle, Up ramp, Dn ramp
	Modulation Frequency	2mHz to 20kHz (Int) DC to 20kHz (Ext)
	SUM depth	0%~100.0%
	Source	Internal / External
<b>PWM Modulation</b>	Carrier Waveforms	Sine, Square, Triangle, Ramp
	Modulating Waveforms	Sine, Square, Triangle, Up ramp, Dn ramp
	Modulation Frequency	2mHz to 20kHz (Int) DC to 20kHz (Ext)
	Phase deviation	0%~100.0% pulse width
	Source	Internal / External
<b>FSK</b>	Carrier Waveforms	Sine, Square, Triangle, Ramp, Pulse
	Modulating Waveforms	50% duty cycle square
	Internal Frequency	2mHz to 1 MHz



	Frequency Range	1μHz to max frequency
	Source	Internal / External
<b>Sweep</b>		
	Waveforms	Sine, Square, Triangle, Ramp
	Type	Linear or Logarithmic
	Sweep direction	Sweep up or sweep down
	Start/Stop Freq	1uHz to max frequency
	Sweep Time	1ms to 500s
	Source	Internal / External
	Trigger	Single, External, Internal.
	Marker	Marker signal on falling edge(programmable)
	Source	Internal / External
<b>Burst</b>		
	Waveforms	Sine, Square, Triangle, Ramp
	Frequency	Max Frequency 25MHz
	Pulse count	1~1000000 Cycles or infinite
	Start/ Stop Phase	-360.0° ~+360.0°
	Internal Frequency	1 us~500 s
	Gate source	External Trigger
	Trigger Source	Single, External, Internal.
<b>Trigger Delay</b>	NCycle, Infinite	0s~100 s
<b>External Trigger Input</b>		
	Type	For FSK, Burst, Sweep
	Input Level	TTL Compatibility
	Slope	Rising or Falling(Selectable)
	Pulse Width	>100ns
	Input Impedance	10kΩ, DC coupled
<b>External Modulation Input</b>		
	Type	For AM,FM, PM,SUM,PWM
	Voltage Range	±5V full scale
	Input Impedance	10kΩ
	Frequency	DC to 20kHz
	Ground Isolation	42Vpk max
<b>Trigger Output</b>		
	Type	For ARB,Burst,Sweep

<b>Frequency Counter</b>	Level	TTL Compatible into 50Ω
	Pulse Width	>16ns
	Maximum Rate	25MHz
	Fan-out	≥4 TTL Load
	Impedance	50Ω Typical
	Range	5Hz to 150MHz
	Accuracy	Time Base accuracy±1count
	Time Base	±20ppm (23 °C ±5 °C)
	Resolution	The maximum resolution is: 100nHz for 1Hz, 0.1Hz for 100MHz.
	Input Impedance	1kΩ/1pf
Sensitivity	35mVrms ~ 30Vrms (5Hz to 150MHz)	
Ground Isolation	42Vpk max	
<b>Dual Channel Function (CH1/CH2)</b>		
Phase	-180° ~180°	
	Synchronize phase	
Track	CH2=CH1	
Coupling	Frequency(Ratio or Difference) Amplitude & DC Offset	
Dsolk	√	
<b>Save/Recall</b>	10 Groups of Setting Memories	
<b>Interface</b>	LAN, USB	
<b>Display</b>	4.3" TFT LCD 480 × 3 (RGB) × 272	
<b>General Specifications</b>		
Power Source	AC100~240V, 50~60Hz or AC100~120V, AC220~240V, 50~60Hz	
Power Consumption	30W or 80W (With power amplifier)	
Operating Environment	Temperature to satisfy the specification : 18 ~ 28 °C	

	Operating temperature :
	0 ~ 40 °C
	Relative Humidity:
	≤ 80%, 0 ~ 40 °C
	≤70%, 35 ~ 40 °C
	Installation category : CAT II
Operating Altitude	2000 Meters
Pollution Degree	IEC 61010 degree 2, Indoor use
Storage Temperature	-10~70 °C, Humidity: ≤70%
Dimensions (WxHxD)	266(W) x 107(H) x293(D)mm
Weight	Approx. 2.5kg
Safety designed to	EN61010-1
Accessories	GTL-101× 1(MFG-21XX) GTL-101× 2(MFG-22XX) Quick Start Guide ×1 CD (user manual + software) ×1 Power cord×1

- (1). A total of ten waveforms can be stored. (Every waveform can be composed of a maximum of 16k points.)
- (2). Add 1/10th of output amplitude and offset specification per °C for operation outside of 0°C to 28°C range (1-year specification).
- (3). DC offset set to zero,
- (4). Jitter specification for RF Generator: 20ppm+5ns.
- (5). Only Pluse channel support
- (6). Only one channel output

## EC Declaration of Conformity

We

**GOOD WILL INSTRUMENT CO., LTD.**

No.7-1, Jhongsing Rd., Tucheng Dist., New Taipei City 236, Taiwan

**GOOD WILL INSTRUMENT (SUZHOU) CO., LTD.**

No. 69, Lushan Road, Suzhou New District Jiangsu, China

declares that the below mentioned product  
**MFG-2110, MFG-2120, MFG-2120MA, MFG-2130M, MFG-2230M, MFG-2260M, MFG-2160MF, MFG-2260MFA, MFG-2160MR, MFG-2260MRA**  
 Are here with confirmed to comply with the requirements set out in the Council Directive on the Approximation of the Law of Member States relating to Electromagnetic Compatibility (2004/108/EC&2014/30/EU) and Low Voltage Equipment Directive EMC: 2014/30/EU, LVD: 2014/35/EU, WEEE: 2012/19/EU and RoHS: 2011/65/EU. For the evaluation regarding the Electromagnetic Compatibility and Low Voltage Equipment Directive, the following standards were applied:

© EMC

<b>EN 61326-1:</b>	<b>Electrical equipment for measurement, control and laboratory use — EMC requirements (2013)</b>	
<b>EN 61326-2-1:</b>		
Conducted and Radiated Emissions EN 55011: 2009+A1:2010	Electrostatic Discharge EN 61000-4-2: 2009	
Current Harmonic EN 61000-3-2: 2014	Radiated Immunity EN 61000-4-3: 2006+A1 : 2008+A2:2010	
Voltage Fluctuation EN 61000-3-3: 2013	Electrical Fast Transients IEC 61000-4-4: 2012	
-----	Surge Immunity EN 61000-4-5: 2006	
-----	Conducted Susceptibility EN 61000-4-6: 2014	
-----	Power Frequency Magnetic Field EN 61000-4-8: 2010	
-----	Voltage Dips/ Interrupts IEC 61000-4-11: 2004	

© Safety

<b>Low Voltage Equipment Directive 2014/35/EU</b>
Safety Requirements IEC/EN 61010-1: 2010(Third Edition)

## GLOBAL HEADQUARTERS

### **GOOD WILL INSTRUMENT CO., LTD.**

No. 7-1, Jhongsing Road, Tucheng Dist., New Taipei City 236,  
Taiwan

Tel: +886-2-2268-0389

Fax: +866-2-2268-0639

Web: [www.gwinstek.com](http://www.gwinstek.com)

Email: [marketing@goodwill.com.tw](mailto:marketing@goodwill.com.tw)

### **GOOD WILL INSTRUMENT (SUZHOU) CO., LTD.**

No. 521, Zhujiang Road, Snd, Suzhou Jiangsu 215011, China

Tel: +86-512-6661-7177

Fax: +86-512-6661-7277

Web: [www.instek.com.cn](http://www.instek.com.cn)

Email: [marketing@instek.com.cn](mailto:marketing@instek.com.cn)

### **Europe Subsidiary**

#### **GOOD WILL INSTRUMENT EURO B.V.**

De Run 5427A, 5504DG Veldhoven, The Netherlands

Tel: [+31\(0\)40-2557790](tel:+31(0)40-2557790)

Fax: [+31\(0\)40-2541194](tel:+31(0)40-2541194)

Email: [sales@gw-instek.eu](mailto:sales@gw-instek.eu)